

Multi Pulse Meters



MP5S / MP5Y / MP5W Series PRODUCT MANUAL

For your safety, read and follow the considerations written in the instruction manual, other manuals and Autonics website.

The specifications, dimensions, etc. are subject to change without notice for product improvement. Some models may be discontinued without notice.

Features

- 16 operation modes
 - Frequency / revolutions / speed, passing speed, cycle, passing time, time interval
 - Time differential, absolute ratio, error ratio, density, error, length measurement 1 / 2, interval
 - Accumulation, addition / subtraction (individual input), addition / subtraction (phase difference input)
- Various output models
 - Relay triple / quintuple output, NPN / PNP open collector quintuple output
 - BCD Dynamic output, PV transmission output (current output)
 - RS485 communication output (Modbus RTU)
- Various function
 - Prescale, delay monitoring, hysteresis, auto-zero, parameter lock, data bank (MP5W only)
- Display range: -19999 to 99999
- Various display units

Safety Considerations

- Observe all 'Safety Considerations' for safe and proper operation to avoid hazards.
- ⚠ symbol indicates caution due to special circumstances in which hazards may occur.

⚠ Warning Failure to follow instructions may result in serious injury or death.

- 01. Fail-safe device must be installed when using the unit with machinery that may cause serious injury or substantial economic loss. (e.g. nuclear power control, medical equipment, ships, vehicles, railways, aircraft, combustion apparatus, safety equipment, crime / disaster prevention devices, etc.)**
Failure to follow this instruction may result in personal injury, economic loss or fire.
- 02. Do not use the unit in the place where flammable / explosive / corrosive gas, high humidity, direct sunlight, radiant heat, vibration, impact, or salinity may be present.**
Failure to follow this instruction may result in explosion or fire.
- 03. Install on a device panel to use.**
Failure to follow this instruction may result in fire or electric shock.
- 04. Do not connect, repair, or inspect the unit while connected to a power source.**
Failure to follow this instruction may result in fire or electric shock.
- 05. Check 'Connections' before wiring.**
Failure to follow this instruction may result in fire.
- 06. Do not disassemble or modify the unit.**
Failure to follow this instruction may result in fire or electric shock.

⚠ Caution Failure to follow instructions may result in injury or product damage.

- 01. When connecting the power / measurement input and relay output, use AWG 24 (0.20 mm²) to AWG 15 (1.65 mm²) cable and tighten the terminal screw with a tightening torque of 0.98 to 1.18 N m.**
Use the wiring suitable for the load current capacity.
Failure to follow this instruction may result in fire or malfunction due to contact failure.
- 02. Use the unit within the rated specifications.**
Failure to follow this instruction may result in fire or product damage.
- 03. Use dry cloth to clean the unit, and do not use water or organic solvent.**
Failure to follow this instruction may result in fire or electric shock.
- 04. Keep the product away from metal chip, dust, and wire residue which from flowing into the unit.**
Failure to follow this instruction may result in fire or product damage.

Cautions during Use

- Follow instructions in 'Cautions during Use'.
Otherwise, it may cause unexpected accidents.
- Power supply should be insulated and limited voltage / current or Class 2, SELV power supply device.
- Install a power switch or circuit breaker in the easily accessible place for supplying or disconnecting the power.
- Use twisted pair wire for communication line.
- Keep away from high voltage lines or power lines to prevent inductive noise.
In case installing power line and input signal line closely, use line filter or varistor at power line and shielded wire at input signal line. Do not use near the equipment which generates strong magnetic force or high frequency noise.
- This unit may be used in the following environments.
 - Indoors (in the environment condition rated in 'Specifications')
 - Altitude max. 2,000 m
 - Pollution degree 2
 - Installation category II

Ordering Information

This is only for reference, the actual product does not support all combinations. For selecting the specified model, follow the Autonics website.

MP 5 ① - ② ③

① Size

S: DIN W 48 × H 48 mm
Y: DIN W 72 × H 36 mm
W: DIN W 96 × H 48 mm

② Power supply

2: 24 VAC ~ 50 / 60 Hz, 24 - 48 VDC ==
4: 100 - 240 VAC ~ 50 / 60 Hz

③ Output

Output	Main (comparative value) output	Sub (display value) output
MP5S	N	Indicator
	N	Indicator
	1	NPN open collector quintuple
MP5Y	2	PNP open collector quintuple
	3	Indicator
	4	Indicator
	5	Indicator
	6	Relay triple (H, GO, L)
	N	Indicator
MP5W	A	Relay quintuple (HH, H, GO, L, LL)
	1	Relay triple (H, GO, L)
	2	NPN open collector quintuple
	4	NPN open collector quintuple
	5	PNP open collector quintuple
	8	NPN open collector quintuple
	9	PNP open collector quintuple
	2	BCD Dynamic
	4	PV transmission (current)

Dimensions

- Unit: mm, For the detailed drawings, follow the Autonics website.
- This dimensions shows the indicator. The connector (side length) is different according to the output specification.

■ MP5S

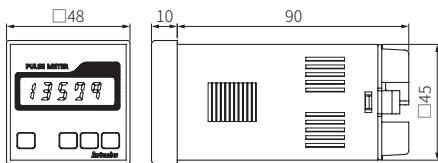

■ MP5Y

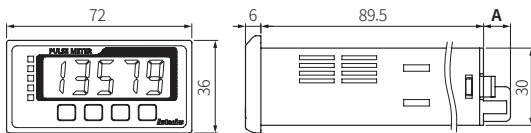

■ MP5W

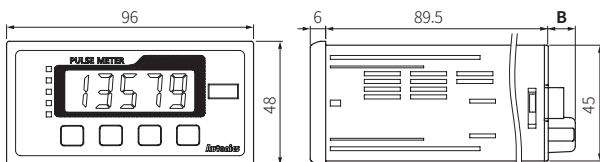

	MP5Y-□N	MP5Y-□1/2/3/4/5	MP5Y-□6	MP5W-□N	MP5W-□A/1	MP5W-□2/4/5/8/9
A	10.5	14.5	15.3	-	-	-
B	-	-	-	10.5	10.5	14.5

■ Bracket

• MP5S

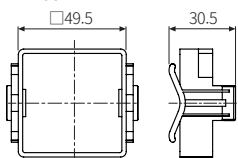

• MP5Y / MP5W

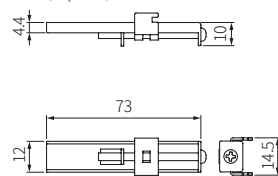

■ Panel cut-out

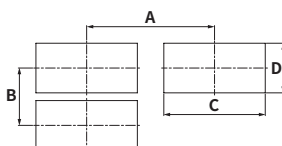

	A	B	C	D
MP5S	≥ 65	≥ 65	45 ^{+0.05}	45 ^{+0.05}
MP5Y	≥ 91	≥ 40	68 ^{+0.07}	31.5 ^{+0.05}
MP5W	≥ 116	≥ 52	92 ^{+0.08}	45 ^{+0.06}

Manual

For proper use of the product, refer to the manuals and be sure to follow the safety considerations in the manuals.

Download the manuals from the Autonics website.

Software

Download the installation file and the manuals from the Autonics website.

■ DAQMaster

It is the comprehensive device management program for Autonics' products, providing parameter setting, monitoring and data management.

Cautions during Wiring

- Unit: mm, Use terminals of size specified below.

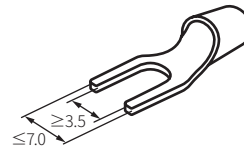

- Contact the manufacture for the socket and cable.

Model	Specification	Manufacture
MP5Y-□1/2/3/4/5	Hirose connector	HIF3BA-10PA-2.54DS
	Applied connector socket	HIF3BA-10D-2.54R
MP5W-□2/4/5/8/9	Hirose connector	HIF3BA-20PA-2.54DS
	Applied connector socket	HIF3BA-20D-2.54R
	I/O cable (sold separately)	CO20-HP□-□

Connections

- Indicator model supports only power / input terminals.
- Connector or terminal block support varies by model. Refer to the cautions during wiring.
- HOLD / RESET terminal function is different depending on the operation mode. (F1 to F12: HOLD, F13 to F16: RESET)

■ MP5S

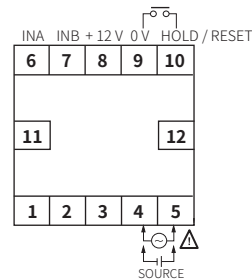

■ MP5Y

• Power / input terminal

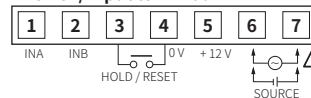

• 1: NPN open collector output

MAIN OUT (NPN OPEN COLLECTOR)
30 VDC ≒ 30 mA

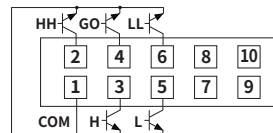

• 2: PNP open collector output

MAIN OUT (PNP OPEN COLLECTOR)
30 VDC ≒ 30 mA

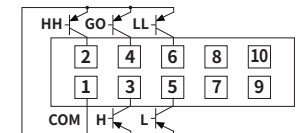

• 3: BCD Dynamic output

BCD OUT (NPN OPEN COLLECTOR)
30 VDC ≒ 30 mA

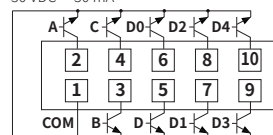

• 4: PV transmission output

DC 4 - 20 mA / DC 0 - 20 mA
Load 500 Ω Max.

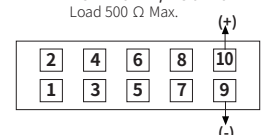

• 5: RS485 communication output

RS485 B (-)

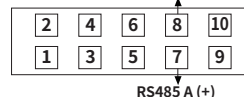

• 6: relay triple output

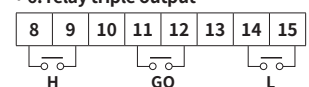

CONTACT OUT:
250 VAC ~ 3 A, 30 VDC ≒ 3 A RESISTIVE LOAD

MP5W

Power / input terminal

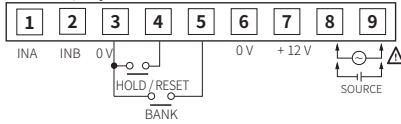

A: relay quintuple output

CONTACT OUT:
250 VAC ~ 3 A, 30 VDC = 3 A RESISTIVE LOAD

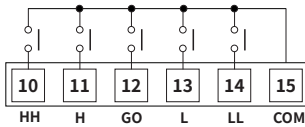

1: relay triple output

CONTACT OUT:
250 VAC ~ 3 A, 30 VDC = 3 A RESISTIVE LOAD

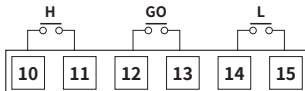

2: NPN open collector + BCD Dynamic output

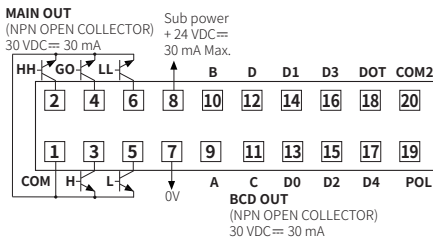

POL signal turns ON when the display value is a minus (-) value.

4: NPN open collector + PV transmission output

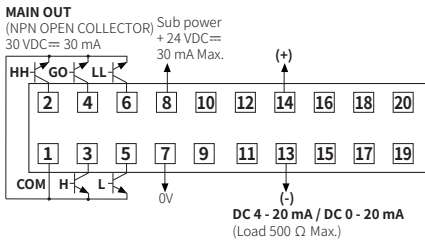

5: PNP open collector + PV transmission output

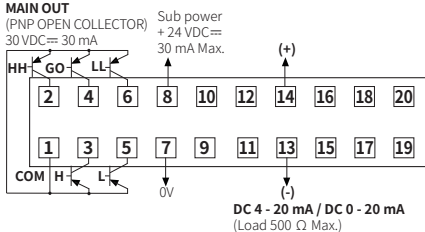

8: NPN open collector + RS485 comm.

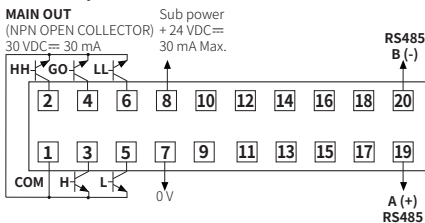

9: PNP open collector + RS485 comm.

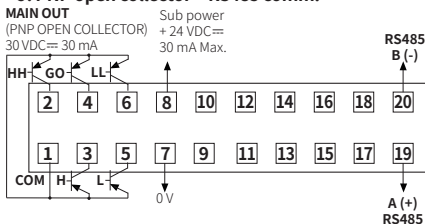

Specifications

Series	MP5S	MP5Y	MP5W
Input signal⁰¹⁾	Solid state input 1: ≤ 50 kHz (pulse width: ≥ 10 μs) Solid state input 2 ⁰²⁾ : ≤ 5 kHz (pulse width: ≥ 100 μs) Contact input: ≤ 45 Hz (contact: 12 VDC = ≥ 5 mA, pulse width: ≥ 11 ms)		
Voltage input	Input impedance: 3.9 kΩ, [H]: 4.5 - 24 VDC =, [L]: 0 - 1 VDC =		
No-voltage input	Short-circuit impedance: ≤ 80 Ω, residual voltage: ≤ 1 VDC =, open-circuit impedance: ≥ 100 kΩ		
Display method	7-segment LED (zero blanking method)		
Character size	W 4 × H 8 mm	W 7 × H 14 mm	
Prescale	0.0001 × 10 ⁹ to 9.9999 × 10 ⁹		
Hysteresis	0 to 9999 ⁰³⁾		
Display cycle	OFF ⁰⁴⁾ , 0.05, 0.5, 1, 2, 4, 8 sec (same as update output cycle)		
Display range	-19999 to 99999		
Output	Depending on models		
Relay	250 VAC ~ 3 A, 30 VDC = 3 A resistive load		
NPN / PNP open collector	≤ 30 VDC = 30 mA		
BCD Dynamic	NPN open collector ≤ 30 VDC = 30 mA (Dynamic COM cycle (T) = 40 ms)		
PV transmission	DC 4 - 20 mA (load: ≤ 500 Ω, resolution: 8,000 divisions) / DC 0 - 20 mA (load: ≤ 500 Ω, resolution: 10,000 divisions)		
RS485 communication	Modbus RTU		
Product components	Product, instruction manual		
Bracket	Mounted	× 2	× 2
Unit sticker	× 1	× 1	× 2
Unit weight (package)	≈ 132 g (≈ 191 g)	≈ 140 g (≈ 230 g)	≈ 210 g (≈ 334 g)
Approval	CE, RoHS, ENEC		

01) Standard duty ratio 1:1

02) Operation mode F7, F8, F9, F10: ≤ 1 kHz (pulse width: ≥ 500 μs)

03) The hysteresis setting range varies according to the decimal point setting position.

04) Only available operation mode F2, F16

	AC voltage	AC / DC voltage
Power supply	100 - 240 VAC ~ ± 10 % 50 / 60 Hz	24 VAC ~ ± 10 % 50 / 60 Hz, 24 - 48 VDC = ± 10 %
Power consumption	Depending on Series / power supply	
MP5S	≤ 7.5 VA	AC: ≤ 6 VA, DC: ≤ 4.5 W
MP5Y	≤ 9 VA	AC: ≤ 7 VA, DC: ≤ 6.2 W
MP5W	≤ 15 VA	AC: ≤ 11 VA, DC: ≤ 7 W
External power supply	≤ 12 VDC = ± 10 % 80 mA	
Sub power supply⁰¹⁾	≤ 24 VDC = 30 mA	
Memory retention	Number of inputs: 100,000 operations (non-volatile semiconductor memory type)	
Relay life cycle	Mechanical: ≥ 10,000,000 operations (switching frequency 180 operations / min) Electrical: ≥ 100,000 operations (250 VAC ~ 3 A, 30 VDC = 3 A resistive load) (switching frequency 20 operations / min)	
Insulation resistance	≥ 100 MΩ (500 VDC = megger)	
Dielectric strength	2,000 VAC ~ 60 Hz for 1 min	
Noise immunity	± 2 kV the square wave noise (pulse width: 1 μs) by the noise simulator	
Vibration	0.75 mm double amplitude at frequency of 10 to 55 Hz in each X, Y, Z direction for 1 hour	
Vibration (malfunction)	0.5 mm double amplitude at frequency of 10 to 55 Hz in each X, Y, Z direction for 10 min	
Shock	300m / s ² (≈ 30G) in each X, Y, Z direction for 3 times	
Shock (malfunction)	100m / s ² (≈ 30G) in each X, Y, Z direction for 3 times	
Ambient temperature	-10 to 50 °C, storage: -20 to 60 °C (no freezing or condensation)	
Ambient humidity	35 to 85 %RH, storage: 35 to 85 %RH (no freezing or condensation)	

01) Only for MP5W

Operation mode	Measurement range	Measurement accuracy (23 ± 5 °C)	
F1	Frequency / revolutions / speed	F.S. ± 0.05 % rdg ± 1 digit	
F2	Passing speed		
F3	Cycle		
F4	Passing time	0.01 to max. of each time range	F.S. ± 0.01 % rdg ± 1 digit
F5	Time interval		
F6	Time differential		
F7	Absolute ratio	0.0005 Hz to 50 kHz	F.S. ± 0.05 % rdg ± 1 digit
F8	Error ratio		
F9	Density		
F10	Error	0 to 99999	-
F11	Length measurement 1		
F12	Interval		
F13	Accumulation	-19999 to 99999	-
F14	Addition / subtraction-individual input		
F15	Addition / subtraction-phase difference input	0 to 99999	-
F16	Length measurement 2		

Communication Interface

RS485

Comm. protocol	Modbus RTU (16-bit CRC)
Application standard	Compliance with EIA RS485
Max. connection	31-unit (address: 1 to 127)
Comm. synchronous method	Asynchronous
Comm. method	2-wire half duplex
Comm. distance	≤ 800 m
Comm. speed	2,400 / 4,800 / 9,600 (default) / 19,200 / 38,400 bps
Comm. response time	5 to 99 ms (default: 20 ms)
Start bit	1-bit (fixed)
Data bit	8-bit (fixed)
Parity bit	None (default), Even, Odd
Stop bit	1-bit, 2-bit (default)

Mode Setting

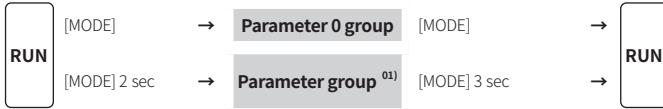

01) Press [▲], [▼] key or [MODE] key for 1.5 sec after entering parameter: select parameter groups.

Parameter Setting

- Some parameters are activated / deactivated depending on the model or setting of other parameters. Refer to the description of each parameter.
- The parameter and setting value are cross-displayed on the display part.
- If any key is not entered for 60 sec in each parameter, it returns to RUN mode.
- [MODE] key: Saves current setting value and moves to the next parameter.
 - [◀] key: Checks fixed value / Changes setting digits.
 - [▲], [▼] key: Changes setting values.

Parameter 0 group

Parameter	Display	Default	Setting range	Display condition
P0-1	HH comparative value	P5t.HH 99999	[Comparative value output model ⁰¹⁾ Operation mode Setting range F1, F2, F7, F9, F11, F12, F13, F16 0 to 99999	P1-4 Output mode: except F
P0-2	H comparative value	P5t.H 99999	F3, F4, F5, F6 0.01 to time setting range	-
P0-3	L comparative value	P5t.L 00000	F8, F10, F14, F15 -19999 to 99999	-
P0-4	LL comparative value	P5t.LL 00000	-	P1-4 Output mode: except F
P0-5	Max. monitoring value	HPt.P 99999	• Varies according to P1-1 Input operation mode and P2-2 Decimal point position of display value • Same parameters at parameter 2 group are linked. • Reset (PV): [◀] key for over 2 sec	P1-1 Input operation mode: except F13, F16
P0-6	Min. monitoring value	L.Pt.P 49999		

Parameter	Comparative value output model	
	Quintuple	Triple
01) HH comparative value	<input type="radio"/>	-
H comparative value	<input type="radio"/>	<input type="radio"/>
L comparative value	<input type="radio"/>	<input type="radio"/>
LL comparative value	<input type="radio"/>	-

Parameter 1 group

Parameter	Display	Default	Setting range	Display condition	
P1-1	Input operation mode	n o d E	F I	F1 to F16	-
P1-2	Input A sensor type	i n - A	n P n . H F	NPN.H.F: NPN non-contact input1 NPN.M.F: NPN non-contact input2 NPN.L.F: NPN contact input	-
P1-3	Input B sensor type	i n - b	n P n . H F	PNP.H.F: PNP non-contact input1 PNP.M.F: PNP non-contact input2 PNP.L.F: PNP contact input	P1-1 Input operation mode: F2, F6 to 14, F16 ⁰¹⁾
P1-4	Output mode	o U t - t	5 t A r d	[Comparative value output model] STARD: S (Standard) OUT-H: H (High) OUT-L: L (Low) OUT-B: B (Block) OUT-I: I (One-shot) OUT-F: F (Deflection) *	P1-1 Input operation mode: except F13 & * P1-1 Input operation mode: except F16
P1-5	Output hysteresis	H Y S	0 0 0 I	[Comparative value output model] 0000 to 9999 • Varies according to P2-2 Decimal point position of display value	P1-1 Input operation mode: F1, F7 to 10
P1-6	Delay monitoring	G U A r d	F . d E F Y	[Comparative value output model] F.DEFY: LL, L comparative output limit * START: Start compensation timer ⁰²⁾	P1-1 Input operation mode: F1 to 12 *P1-4 Output mode: S, B, F
P1-7	Start compensation timer	5 t A r - t	0 0	[Comparative value output model] 0.0 to 99.9 sec	P1-6 Delay monitoring: START
P1-8	Input A auto-zero time	A U t o A	9 9 9 9 9	0.1 to 9999.9 sec	P1-1 Input operation mode: F1, F4, F7 to 10
P1-9	Input B auto-zero time	A U t o b	9 9 9 9 9		P1-1 Input operation mode: F7 to 10
P1-10	Memory retention	n E n o	o F F	OFF, ON	P1-1 Input operation mode: F13 to 16

01) In case of P1-1 Input operation mode F15, input B sensor type is not displayed and IN-B setting is same as IN-A.
02) [▲] key: Entering compensation time setting

Parameter 2 group

Parameter	Display	Default	Setting range	Display condition	
P2-1	Data bank	P . b A n t	I	[MP5W model] 1, 2	-
P2-2	Decimal point position of display value	d o t	0 0 0 0 0	00000, 0000.0, 000.00, 00.000, 0.0000	P1-1 Input operation mode: F1 to 2, F7 to 16
P2-3	Time unit ⁰¹⁾	t . U n t	t . S E t	T.SEC, T.MIN	-
P2-4	Time range (unit: sec) ⁰¹⁾	t . S E t	9 9 9 9 9	999.99: 999.99 s 9999.9: 9999.9 s 99.59.9: 99 m 59.9 s 9.59.59: 9 h 59 m 59 s 99999: 99999 s	P1-1 Input operation mode: F3 to 6
P2-5	Time range (unit: min) ⁰¹⁾	t . n i n	9 9 9 9 9	999.99: 999.99 m 9999.9: 9999.9 m 99.59.9: 99 h 59.9 m 9.59.59: 999 h 59 m 99999: 99999 m	-
P2-6	HH comparative value	P 5 t . H H	9 9 9 9 9	[Comparative value output model] linked with parameter 0 group parameters	P1-4 Output mode: except F
P2-7	H comparative value	P 5 t . H	9 9 9 9 9		-
P2-8	L comparative value	P 5 t . L	0 0 0 0 0		-
P2-9	LL comparative value	P 5 t . L L	0 0 0 0 0	-	P1-4 Output mode: except F
P2-10	Input A prescale mantissa (x)	P 5 t . A H	6 0 0 0 0	0.0001 to 9.9999	P1-1 Input operation mode: F1 to 2, F4, F7 to 16
P2-11	Input A prescale exponent (y)	P 5 t . A Y	I 0 0 I	10 - 9 (10 ⁻⁹) to 10 09 (10 ⁹)	-
P2-12	Input B prescale mantissa (x)	P 5 t . b H	6 0 0 0 0	0.0001 to 9.9999	P1-1 Input operation mode: F7 to 10
P2-13	Input B prescale exponent (y)	P 5 t . b Y	I 0 0 I	10 - 9 (10 ⁻⁹) to 10 09 (10 ⁹)	-
P2-14	Display cycle	d i S P t	0 0 5	OFF ⁰²⁾ or 0.05, 0.5, 1, 2, 4, 8 sec	P1-1 Input operation mode: F1 to 2, F7 to 10, F16
P2-15	Input B setting value (INB)	t o U n b	9 9 9 9 9	1 to 99999	P1-1 Input operation mode: F16

01) To enter P2-4 time range (unit: sec) and P2-5 time range (unit: min) setting, press [▲] key at P2-3 time unit.
02) Only available operation mode F2, F16

Parameter 3 group

Parameter	Display	Default	Setting range	Display condition	
P3-1	Max. PV transmission output value	F 5 - H	9 9 9 9 9	[PV transmission (current) output model] min. value to max. value (FS-H ≥ FS-L + 1) Operation mode Setting range F1, F2, F7, F9, F11, F12, F13, F16 0 to 99999	-
P3-2	Min. PV transmission output value	F 5 - L	0 0 0 0 0	F3, F4, F5, F6 0.01 to time setting range F8, F10, F14, F15 -19999 to 99999 • Varies according to P1-1 Input operation mode and P2-2 Decimal point position of display value	-
P3-3	current output	n A	4 - 2 0	[PV transmission (current) output model] 4-20, 0-20 mA	-
P3-4	Comm. address	A d d r	0 I	[RS485 communication output model] 01 to 99	-
P3-5	Comm. speed	b P S	9 6 0 0	[RS485 communication output model] 2400, 4800, 9600, 19200, 38400 bps	-
P3-6	Comm. parity bit	P r t y	n o n E	[RS485 communication output model] NONE, EVEN, ODD	-
P3-7	Comm. stop bit	S t P	2	[RS485 communication output model] 1, 2	-
P3-8	Comm. response waiting time	r S Y t	2 0	[RS485 communication output model] Comm. speed Setting range 2400 bps 16 to 99 ms 4800 bps 8 to 99 ms 9600, 19200, 38400 bps 5 to 99 ms • Setting range varies according to P3-5 Comm. speed	-
P3-9	Comm. write	t o n t	d i S A	[RS485 communication output model] ENA: enable, DISA: disable	-
P3-10	Lock	L o t	o F F	OFF: Unlock LOC.0: Lock All LOC.1: Lock parameter 1 / 2 / 3 LOC.2: Lock parameter 2 / 3 LOC.3: Lock parameter 3	-
P3-11	Parameter reset	n r S t	E n A	ENA: enable, DISA: disable	-

Output Mode

Output mode is available to set. (Indicator does not support output mode.)

ON: OFF: H: hysteresis

S (Standard) output mode

- Comparative value setting condition: individual output operation regardless of size or order of set comparative values

HH output: Display value \geq Comparative value HH
 H output: Display value \geq Comparative value H
 L output: Display value \leq Comparative value L
 LL output: Display value \leq Comparative value LL
 GO output: No HH, H, L, LL output

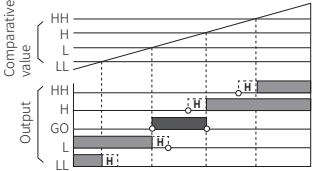

L (Low) output mode

- Comparative value setting condition: individual output operation regardless of size or order of set comparative values

HH output: Display value \leq Comparative value HH
 H output: Display value \leq Comparative value H
 L output: Display value \leq Comparative value L
 LL output: Display value \leq Comparative value LL
 GO output: No HH, H, L, LL output

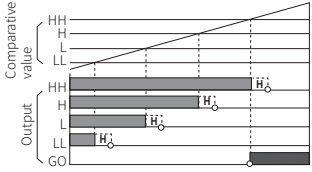

I (One-shot) output mode

- Comparative value setting condition: individual output operation regardless of size or order of set comparative values
- One-shot output time: 0.3 sec (fixed)
- No GO output.
- No hysteresis.

HH output: Display value \geq Comparative value HH
 H output: Comparative value HH $>$ Display value \geq Comparative value H
 L output: Comparative value H $>$ Display value \geq Comparative value L
 LL output: Comparative value L $>$ Display value \geq Comparative value LL

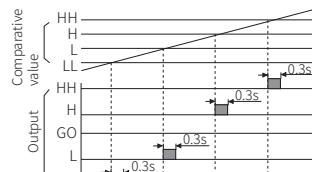

H (High) output mode

- Comparative value setting condition: individual output operation regardless of size or order of set comparative values

HH output: Display value \geq Comparative value HH
 H output: Display value \geq Comparative value H
 L output: Display value \geq Comparative value L
 LL output: Display value \geq Comparative value LL
 GO output: No HH, H, L, LL output

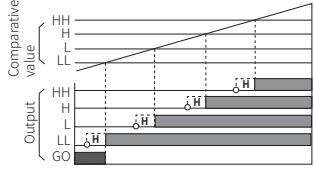

B (Block) output mode

- Comparative value setting condition: $LL < L < H < HH$

HH output: Display value \geq Comparative value HH
 H output: Comparative value HH $>$ Display value \geq Comparative value H
 L output: Comparative value LL $<$ Display value \leq Comparative value L
 LL output: Display value \leq Comparative value LL
 GO output: No HH, H, L, LL output

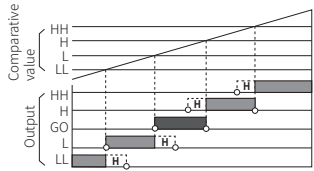

F (Deflection) output mode

- Transmits outputs when the saved setting value exceeds H deviation or L deviation.
- Comparative value setting: Based on the set value, set the H / L deviation in the P0-2, P2-7 H comparative value and P0-3, P2-8 L comparative value parameters. (The set deviation value is saved during Power OFF until it is re-set.)

Comparative value setting range: 0.0001 to 99999
 The setting range is different according to the P2-2 Decimal point position of display value setting.

E.g.) In case of P2-2 Decimal point position of display value = 0000.0, setting range = 0.1 to 9999.9

- Saving setting value: [MODE] + \blacktriangle
- Checking setting value: \blacktriangle
- No HH, GO, LL output.
- The deviation can be set to "0" but the actual operation will be the same as "1".

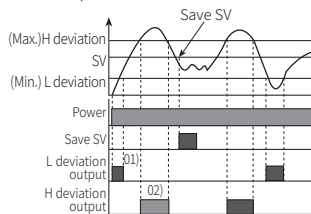

01) When P1-6 Delay monitoring = F.DEFY is set, there is no output.
 02) The graph is assuming that there is a saved setting value prior to the setting value save point. The actual output position may be different.

Operation Mode

F1: frequency / revolutions / speed

Measures the frequency of input A and displays the calculated frequency, revolutions, and speed.

$$\begin{aligned} \text{Frequency (Hz)} &= f \times \alpha & (\alpha = 1 [\text{sec}]) \\ \text{Revolutions (rpm)} &= f \times \alpha & (\alpha = 60 [\text{sec}]) \\ \text{Speed (m / min)} &= f \times \alpha & (\alpha = 60 L [\text{sec}]) \end{aligned}$$

- L: travel distance of conveyor belt of 1 cycle [m]
- α : prescale value (For multiple objects, $\alpha = 60L / N$)

Display value	Display unit	α
Frequency	Hz	1
	kHz	0.001
	rps	1
Revolutions	rpm (default)	60
	mm / sec	1,000 L
	cm / sec	100 L
Speed	m / sec	1 L
	m / min	60 L
	km / hour	3.6 L

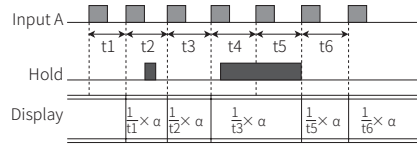
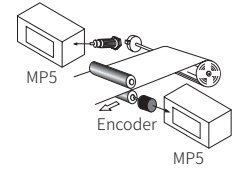

F2: passing speed

Displays the passing speed between input A ON and input B ON.

$$\text{Passing speed (V)} = f \times \alpha \quad (\alpha = L [\text{m}])$$

- f: reciprocal of time [sec] between input A (sensor) ON and input B (sensor) ON.
- L: distance between input A (sensor) and input B (sensor) [m]
- α : prescale value

Display value	Display unit	α
Passing speed	mm / sec	1,000 L
	cm / sec	100 L
	m / sec (default)	1 L
	m / min	60 L
	km / hour	3.6 L

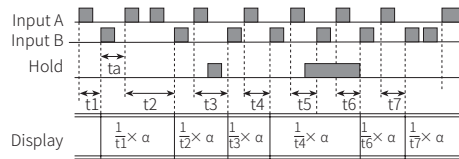
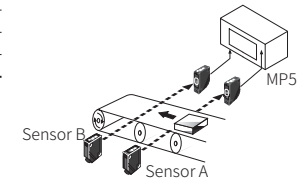

t_a : Return time (≥ 20 ms)

F3: cycle

Displays the measured time from input A ON to the next ON.

$$\text{Cycle (T)} = t$$

- t: measurement time [sec]

Display value	Display unit
Cycle	SEC
	999.99 s (default)
	9999.9 s
	99 m 59.9 s
	9 h 59 m 59 s
99999 s	
	MIN
	999.99 m
	9999.9 m
	99 h 59.9 m
	999 h 59 m
	99999 m

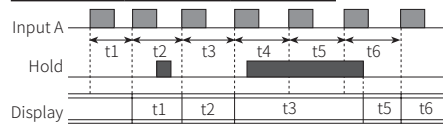
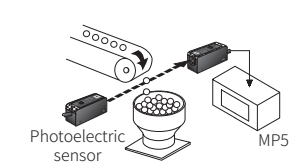

F4: passing time

Measure the time from input A ON to the next ON, and displays the passing time of the arbitrary distance.

$$\begin{aligned} \text{Passing time [sec]} &= t \times \alpha \\ (\alpha &= \frac{L [\text{m}]}{\text{Distance advanced in 1 pulse cycle [m]}}) \end{aligned}$$

- t: measurement time [sec]
- L: arbitrary distance [m]
- α : prescale value

Display value	Display unit
Passing time	SEC
	999.99 s (default)
	9999.9 s
	99 m 59.9 s
	9 h 59 m 59 s
99999 s	
	MIN
	999.99 m
	9999.9 m
	99 h 59.9 m
	999 h 59 m
	99999 m

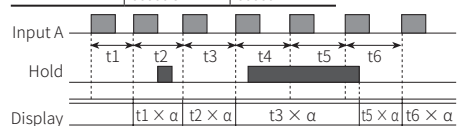
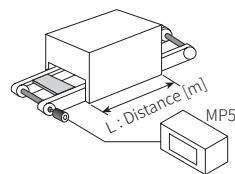

F5: time interval

Displays measured time of input A ON.

$$\text{Time interval (T)} = t$$

t: measured time of input A ON [sec]

Display value	Display unit	
	SEC	MIN
	999.99 s (default)	999.99 m
Time interval	9999.9 s	9999.9 m
	99 m 59.9 s	99 h 59.9 m
	9 h 59 m 59 s	999 h 59 m
	99999 s	99999 m

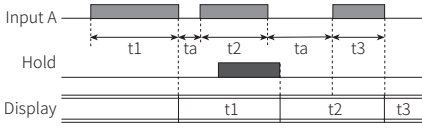
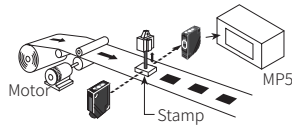

ta: Return time (≥ 20 ms)

F6: time differential

Displays measured time from Input A ON to Input B ON.

$$\text{Time differential (T)} = t (ta \text{ to } tb)$$

t (ta to tb): measured time from input A ON to input B ON [sec]

Display value	Display unit	
	SEC	MIN
	999.99 s (default)	999.99 m
Time differential	9999.9 s	9999.9 m
	99 m 59.9 s	99 h 59.9 m
	9 h 59 m 59 s	999 h 59 m
	99999 s	99999 m

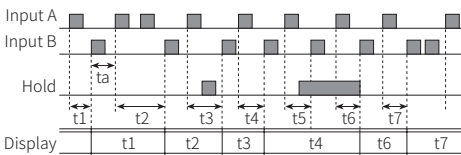
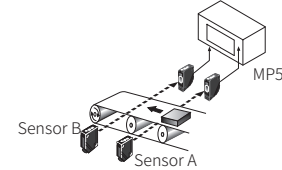

ta: Return time (≥ 20 ms)

F7: absolute ratio

Measures and displays relative speed, amount, speed, etc. of input B against input A in percentage (%).

$$\text{Absolute ratio} = \frac{\text{Input B}}{\text{Input A}} \times 100 [\%]$$

$$\text{Absolute ratio} = \frac{\text{Frequency of input B [Hz]} \times Ba}{\text{Frequency of input A [Hz]} \times Aa} \times 100 [\%]$$

Aa: prescale value of input A
Ba: prescale value of input B

Display value	Display unit
Absolute ratio	%

$$\text{Display} = \frac{\text{Frequency of input B [Hz]} \times Ba}{\text{Frequency of input A [Hz]} \times Aa} \times 100 [\%]$$

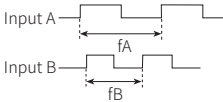
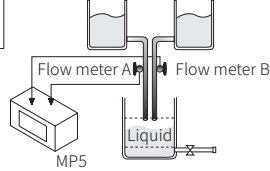

Hold
When the hold signal turns ON, the display value is maintained until the display cycle turns to hold OFF.

F8: error ratio

Measures and displays the relative rate of input B against the reference value of input A in percentage (%).

$$\text{Error ratio} = \frac{\text{Input B} - \text{Input A}}{\text{Input A}} \times 100 [\%]$$

$$\text{Error ratio} = \frac{(\text{frequency of input B [Hz]} \times Ba) - (\text{frequency of input A [Hz]} \times Aa)}{\text{Frequency of input A [Hz]} \times Aa} \times 100 [\%]$$

Aa: prescale value of input A
Ba: prescale value of input B

Display value	Display unit
Error ratio	%

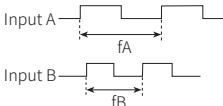
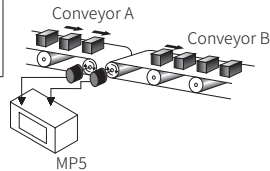

Hold
When the hold signal turns ON, the display value is maintained until the display cycle turns to hold OFF.

F9: density

Measures and displays the density ratio (%) of input B against the total sum of input A and input B.

$$\text{Density} = \frac{\text{Input B}}{\text{Input A} + \text{Input B}} \times 100 [\%]$$

$$\text{Density} = \frac{\text{Frequency of input B [Hz]} \times Ba}{(\text{frequency of input A [Hz]} \times Aa) + (\text{frequency of input B [Hz]} \times Ba)} \times 100 [\%]$$

Aa: prescale value of input A
Ba: prescale value of input B

Display value	Display unit
Density	%

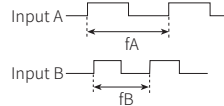
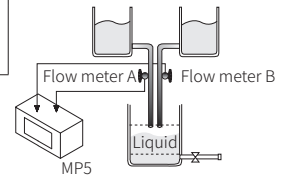

Hold
When the hold signal turns ON, the display value is maintained until the display cycle turns to hold OFF.

F10: error

Measures and displays the error of input B against reference value of input A.

$$\text{Error} = \text{Input B} - \text{Input A}$$

$$\text{Error} = (\text{frequency of input B [Hz]} \times Ba) - (\text{frequency of input A [Hz]} \times Aa)$$

Aa: prescale value of input A
Ba: prescale value of input B

Display value	Display unit
Error	END User setting unit

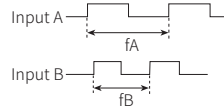
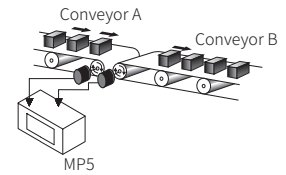

Hold
When the hold signal turns ON, the display value is maintained until the display cycle turns to hold OFF.

F11: length measurement 1

Measure and display the number of input A pulses during input B ON.

$$\text{Length measurement 1} = P \times \alpha$$

P: number of input A pulses
α: prescale value

Display value	Display unit
Length measurement 1	Quantity [EA] (default)
	mm
	cm
	m

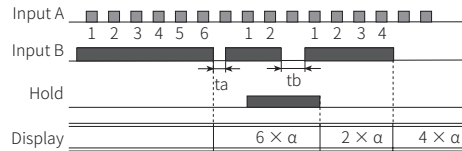
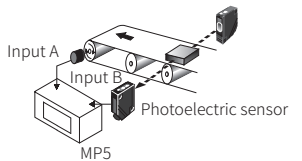

ta, tb: Return time (≥ 20 ms)

F12: interval

Measures and displays the number of input A pulses from input B ON to the next ON.

$$\text{Interval} = P \times \alpha$$

P: number of input A pulses
α: prescale value

Display value	Display unit
Interval	Quantity [EA] (default)
	mm
	cm
	m

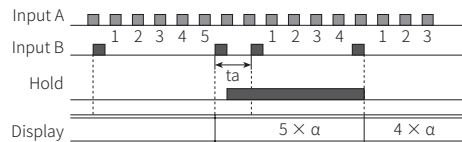
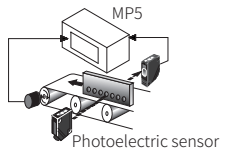

ta: Return time (≥ 20 ms)

F13: accumulation

Measures and displays the counted value of input A pulses.

$$\text{Accumulation} = P \times \alpha$$

- P: number of input A pulses
- α : prescale value

Display value	Display unit
Accumulation	Quantity [EA]

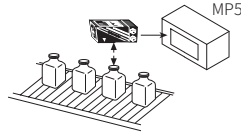

• Operation

- ① Counts the number of input A pulses.
- ② Input B is an enable input signal. During ON, the quantity and display value of input A will be held, and during OFF input A will be recounted.
- ③ When RESET input is ON, the integrated counted value will be reset to "0"

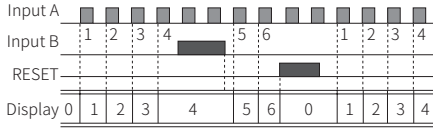

• α = display value for 1

F14: addition / subtraction-individual input

Displays the counted value from added input A pulses and subtracted input B pulses. When there are two inputs simultaneously, it will not count.

$$\text{Add / Sub (individual)} = \text{input A} \times \alpha - \text{input B} \times \alpha$$

- α : prescale value of input A

Display value	Display unit
Addition / Subtraction (individual)	Quantity [EA]

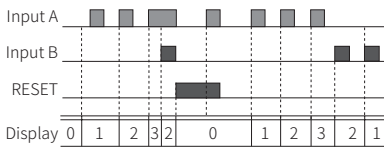
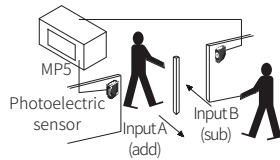

• α = display value for 1

F15: addition / subtraction-phase difference input

When input A is Low, counting is added to the low of input B.
When input A is High, counting is subtracted from the high of input B.

Add / Sub (phase difference) = Detects position and speed using A and B phases of encoder outputs as input.

Display value	Display unit
Addition / Subtraction (phase difference)	Quantity [EA]

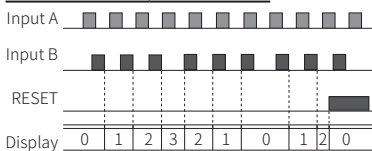
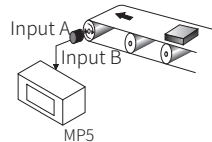

F16: length measurement 2

Measures and displays the number of pulses from input A until the value of input B reaches the setting value.

$$\text{Length measurement 2 (until the setting value of input B)} = P \times \alpha$$

- P: number of input A pulses
- α : prescale value

Display value	Display unit
Length measurement 2	Quantity [EA]

- If input A and input B are ON during initial power supply, it will not count and only count the number of rising edge.
- Display value is renewed depending on the P2-13. Display cycle.

(e.g.: input B = 4)

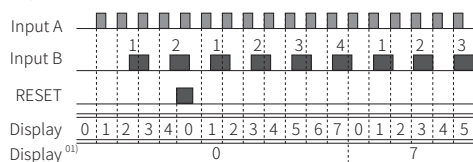

01) When P2-13 Display cycle is OFF, it will maintain the quantity of input A until the value of input B reaches the setting value of P2-14 Input B setting value (INB).

Functions

Hysteresis

Near the comparative setting value, the output may turn ON / OFF frequently and unstably. To prevent this, hysteresis value is set based on the comparative setting value.

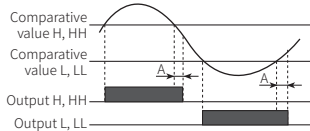

- A: hysteresis
- The hysteresis value can be set to "0" but the actual operation value is "1"

Delay monitoring: limit comparative output

After supplying power, the starting current of motors and other inputs are changeable. This function allows stable control by limiting all outputs for a certain period of time, until the target measurement unit stabilizes. It may also control L,LL outputs until a specific output is reached.

- After supplying power, there is no initial L, LL comparative outputs.
- Each setting value of HH, H, LL, L is not related to their relative sizes.
- E.g.: S (Standard) output mode

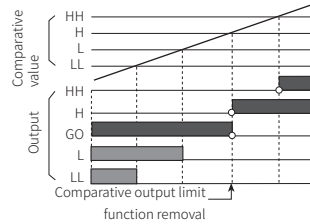

• E.g.: F (Deflection) output mode
The comparative output limiting function is removed at the set value (standard setting).
Comparative output limit
function removal
(Max.)H deviation
SV
(Min.)L deviation
Output
H
L
LL

Delay monitoring: Start compensation timer

Set monitoring delay time so that there is no output during the delay time.

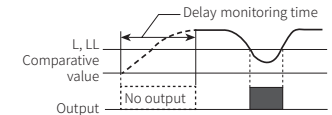

Auto-zero time

When there is no input signal during auto-zero setting time, the display value is automatically set to 0(zero). Please set the auto-zero setting time so that it is longer than the interval of the slowest input signal. If the setting time is too long and there is no input signal, the rate at which the display value falls to 0(zero) decrease, and output response rate may slow down.

Data bank

Comparative setting value and prescale value are saved as two types(data bank 1, 2) and can be selected for use by opening or shorting of terminals.

- Terminal 3, 5 open: use value of data bank 1
- Terminal 3, 5 short: use value of data bank 2

Prescale

Displays values in required units or specific multiples by counting the number of input pulses, then multiplying the number of pulses or the length of pulses by variables (X×10y).

- E.g.: prescale value ($\alpha = 15$) setting

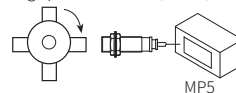

$$\begin{aligned} \text{Revolutions (rpm)} &= f \times \alpha \\ &= f \times 60 \times (1 / N) \\ &= f \times 60 \times (1 / 4) \\ &= f \times 60 \times 0.25 \\ &= f \times 15 \end{aligned}$$

- f: the number of input pulses per second [Hz]
- α : prescale value
- N: the number of pulses per revolution

Set mantissa(X) as 1.5000, and exponent(Y) as 1 for prescale value(α)=15.
The same display value can be obtained with α value set as X=0.1500, and Y=2

Example of Input Connection

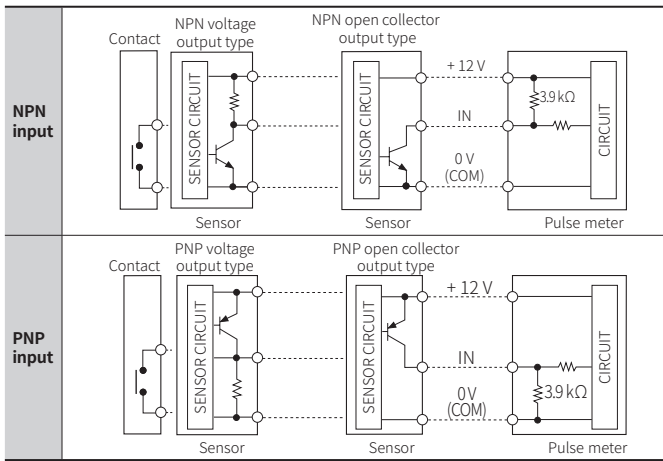

BCD Dynamic Output (negative logic)

- BCD Data (A, B, C, D, DOT) ← A: lowest bit, DOT: highest bit
- Digit Data (D0, D1, D2, D3, D4) ← D0: lowest digit, D4: highest digit
- E.g.: 125.89 Display

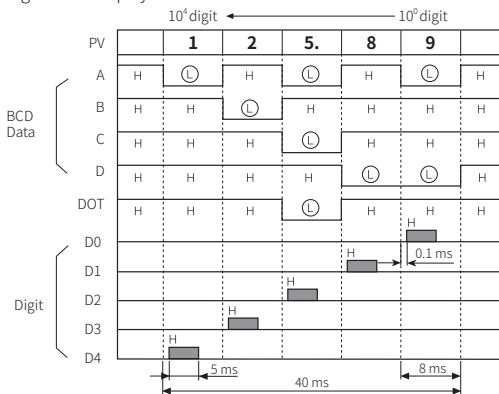

Segment Table

The segments displayed on the product indicate the following meanings. It may differ depending on the product.

7 segment	11 segment	12 segment	16 segment
0	0	0	0
1	1	1	1
2	2	2	2
3	3	3	3
4	4	4	4
5	5	5	5
6	6	6	6
7	7	7	7
8	8	8	8
9	9	9	9
A	A	A	A
b	b	b	b
c	c	c	c
d	d	d	d
E	E	E	E
F	F	F	F
G	G	G	G
H	H	H	H